

## ELECTRONIC ARC HEIGHT SENSOR - E.A.H.S



Lightweight and durable components to reduce operator fatigue.

The 4" (10.16 cm) standard slide features engraved top, bottom and center marks for quick slide position reference to aid setup.

Standard 25 ft. (762 cm) of remote pendant control cable means the current sensor main control box can be kept away from the work area reducing trip hazards; an additional 25 ft. (762 cm) extension is available.

Easy setup and torch calibration.

Sensor control box design allows the operator to use their standard existing welding cables.

Extremely accurate arc detection  
Slide travel speed factory set at 10 IPM  
(25.4 cm/ min), programmable range of 3 IPM  
(7.6 cm/min) to 17 IPM (43.2 cm/min)

Easy to use remote pendant interface with coarse and fine slide adjustment.

### *High Precision Torch Height Adjustment Through Current Detection*

ACCURATE ARC DETECTION AND PRECISION CONTROL OVER THE TORCH HEIGHT



## E.A.H.S SYSTEM COMPONENTS

The Electronic Arc Height Sensor (E.A.H.S.) from Gullco is an automated welding system used throughout the world to automate and improve the quality and efficiency of the weld produced in automatic mechanized welding operation. This is achieved through minimizing weld defects such as poor penetration, incomplete fusion, overlap and undercut. Also, detrimental factors such as poor or awkward accessibility, operator fatigue, or inconsistent workmanship are eliminated. Required quality levels are consistently attained and productivity and profitability increased.

400 AMP GK-203-400



800 AMP GK-203-800

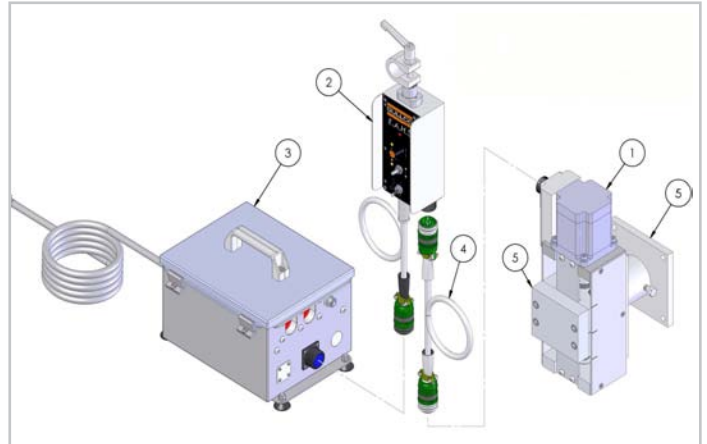

ITEM	PART NO.	DESCRIPTION	QTY.
1	GK-203-001	Slide Assembly	1
2	GK-203-002	E.A.H.S Remote Pendant	1
3	GK-203-003-A	Control Box Assembly 42V Input	1
	GK-203-003-B	Control Box Assembly 115V Input	1
	GK-203-003-C	Control Box Assembly 230V Input	1
4	GK-201-125	Head Cable Assembly	1
5	GC-058	Mounting Hardware	1
6	GK-201-112	Gun Holder Assembly	1

ITEM	PART NO.	DESCRIPTION	QTY.
1	GK-203-007	Heavy Slide Assembly	1
2	GK-203-002	E.A.H.S Remote Pendant	1
3	GK-203-014-A	800 AMP Control Box Assembly 42V Input	1
	GK-203-014-B	800 AMP Control Box Assembly 115V Input	1
	GK-203-014-C	800 AMP Control Box Assembly 230V Input	1
4	GK-201-125	Head Cable Assembly	1
5	GK-203-093	HD Slide Mounting Hardware	1

### VERTICAL SLIDE CAPACITY\*

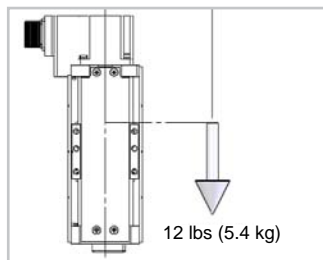

### HORIZONTAL SLIDE CAPACITY\*

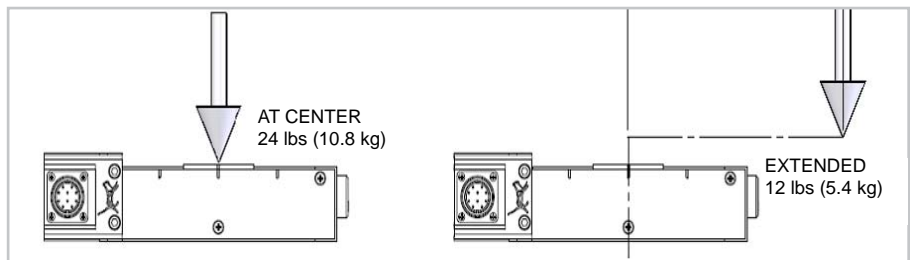

\* For other configuration capacities, please consult your Gullco sales representative or request info at [www.gullco.com](http://www.gullco.com)

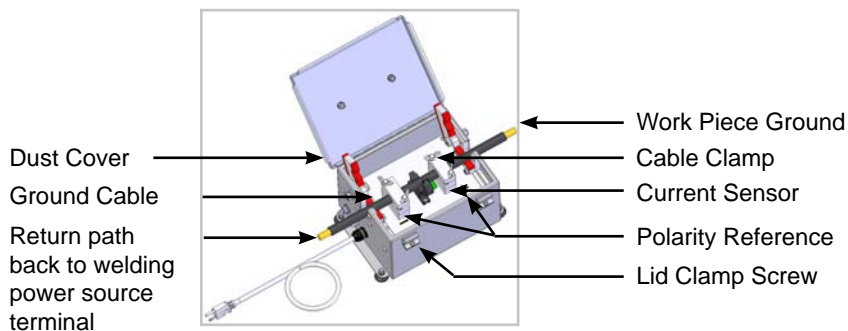

## E.A.H.S REMOTE PENDANT CONTROL

A highly sophisticated, yet easy to use, microprocessor based control drives a high torque, high resolution, low vibration stepper motor located in the linear slide, allowing the height of the welding gun to be precisely controlled. The control interfaces with the linear slide through a removable head cable assembly and with the main control box through a fixed pendant control cable. Controlling the height of the welding torch will allow the quality and appearance of the weld to be perfected.



Power L.E.D

Fine Adjustment Slide Knob

Up Slide Indicator

Control Status Indicator

Down Slide Indicator

Coarse Adjustment Slide Toggle Switch

Manual (Teach) / Auto (Tracking) Switch

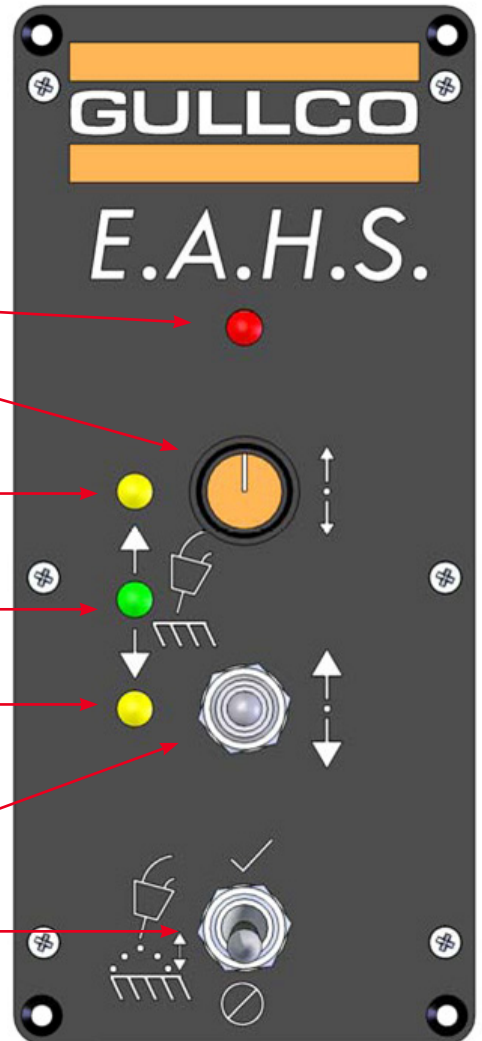

## E.A.H.S UNIT ACCESSORIES

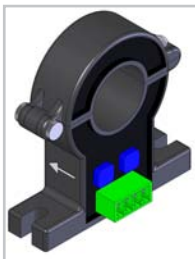

### **GK-203-070: 500 AMP CURRENT SENSOR**

This sensor increases the current sensing range up to 97% of 500 AMPS (485 AMPS). It is a direct replacement for the existing 400 AMP sensor

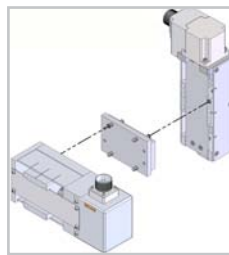

### **GK-203-086 : LINEAR OSCILLATOR TO E.A.H.S SLIDE ADAPTER**

This adapter kit allows the Gullco Linear Oscillator (**GK-201-120**) to be mounted to the E.A.H.S slide (**GK-203-001**). Slides not included.



### **GK-203-092: REMOTE PENDANT EXTENSION 25 FT (762 cm)**

This 25 ft. (762 cm) extension will increase the total length of control cable between the control box and the remote pendant to 50 ft. (1.52 m)

## SPECIFICATIONS

1. GK-203-003: Control Box with 25 ft. (9 m) control cable and 9 ft. (3 m) power cord
2. GK-203-001: Motorized Vertical Correction Slide
3. GK-203-002: Remote Control Pendant with 25 ft. (7.62 m) control cable
4. GK-203-003: Control Box Assembly (A- 42V, B-115V, C-230V)
5. GK-201-125: Motorized Vertical Correction Slide Control Cable - 6 ft. (1.8 m)
6. GC-058: Mounting Hardware
7. GK-201-112: Gun Holder Assembly



The E.A.H.S. works by measuring welding current, comparing it to a target value that has been taught by the operator and automatically adjusting the height of the welding gun to maintain the target welding current.

The Model GK-203-400 is a standalone unit meaning it does not interface with the wire feeder. The arc activation trigger signal of the welding equipment that is used to start/stop the welding process must come from a separate piece of equipment, i.e. customer supplied control or other Gullco equipment. This advanced Electric Arc Height Sensor package uses Gullco's sophisticated, yet easy to use, E.A.H.S. remote pendant control, in conjunction with a 4" linear slide assembly and current sensing control box, to provide precision arc height control during the welding process.

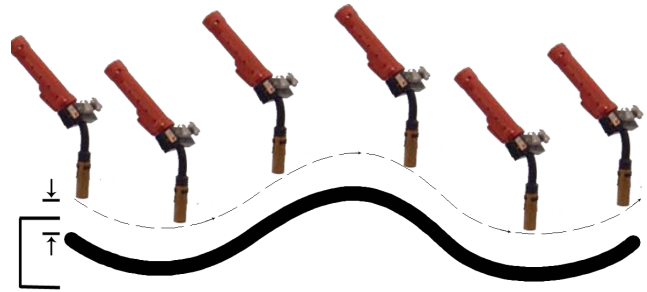

Welding guns are readily mounted on the linear slide. This equipment is intended to automatically control the torch height throughout the welding process. The longitudinal movement can be obtained from either the work piece traveling while the linear remains stationary, or, by a travel carriage such as the Gullco KAT® carriage carrying the E.A.H.S. equipment down the length of the work piece, which is the norm. Combining the welding gun height control with the precision controlled travel speed of the KAT® carriage will ensure high quality workmanship can be produced.



KAT, KBM, MOGGY, KATBAK & SAM are registered trademarks of Gullco Enterprises Limited

Distributed by:

SPECIFICATIONS ARE SUBJECT TO CHANGE WITHOUT NOTICE

<b>GULLCO</b>		
<b>GULLCO INTERNATIONAL LIMITED - CANADA</b>		
Phone: 905-953-4140	Fax: 905-953-4138	e-mail: sales@gullco.com
<b>GULLCO INTERNATIONAL INC. - U.S.A</b>		
Phone: 440-439-8333	Fax: 440-439-3634	e-mail: ussales@gullco.com
<b>GULLCO INTERNATIONAL (U.K.) LIMITED- EUROPE</b>		
Phone: +44 1257-253579	Fax: +44 1257-254629	e-mail: sales@gullco.co.uk
<b>GULLCO INTERNATIONAL PTY LIMITED - AUSTRALIA</b>		
Phone: 61 (0)7 3348 5515	Fax: 61 (0)7 3348 5510	e-mail: ausales@gullco.com
<b>GULLCO INTERNATIONAL INDIA PVT LIMITED - INDIA</b>		
Phone: 91-20-65260382	Fax: 91-20-26836656	e-mail: india.lo@gullco.com
<b>GULLCO INTERNATIONAL SHANGHAI LIMITED- CHINA</b>		
Phone: +8621-50460341	Fax: +8621-50463554	e-mail: gsuntech@sh163.net
<b>GULLCO INTERNATIONAL LIMITED- LATIN AMERICA</b>		
Phone: 55-11-9485-1336	e-mail: rogerio.macedo@gullco.com	
<b>STUCH GMBH &amp; Co. KG SCWEISSTECHNIK - GERMANY</b>		
Phone: (02 03) 72 94 95	Fax: (02 03) 72 94 96	e-mail: info@stuch-schweisstechnik.de